



THE M5



THE BMW M5.



18 Models



20 Highlights

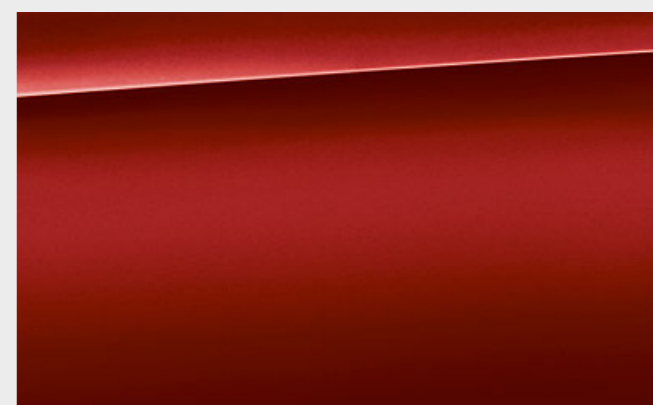

24 Colour worlds

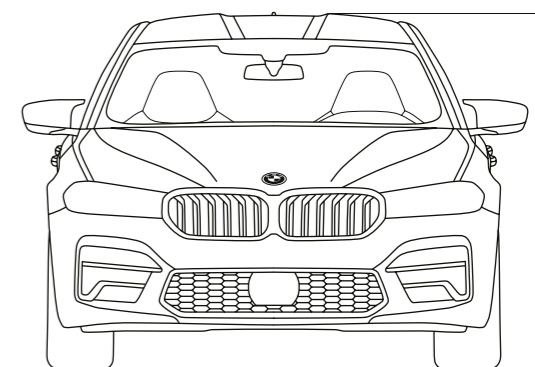

26 Technical data



ALL BMW MODELS
IN ONE APP.

DOWNLOAD THE **BMW Products** APP NOW
AND DISCOVER THE PLEASURE OF DRIVING.



THE M5 COMPETITION



>> DAY 01 — SHOT 0249

GIVE M5.



HEARTBEAT
ACCELERATOR.



HEADSPINNER.



THE M5 COMPETITION



LOST IN FULL SPACE.



>> DAY 02 — SHOT 0063

>> DAY 05 — SHOT 0587



THE M5 COMPETITION

>> DAY 03 — SHOT 0450

LIMIT ENHANCEMENT.



ENDORPHINAL.



>> DAY 03 — SHOT 0440

>> DAY 03 — SHOT 0698 / 0763

HIGHER CLASS.

THE BMW M5 SALOON.

THE M5 COMPETITION

>> DAY 04 — SHOT 0098



BMW M550i xDRIVE.

Discover even more with the new BMW Brochures app. Available now, for your smartphone and tablet.



■ M Leather steering wheel including multifunction buttons, steering wheel rim in leather 'Walknappa' Black with contoured thumb rests.



□ The comfort seats for driver and front passenger* can be adjusted electrically in a variety of ways and provide a perfect seating position for a relaxed arrival.



□ 20" M light alloy wheels Y-spoke style 846 M Bicolour Jet Black with mixed tyres and run-flat tyres, gloss-lathed, wheel size front 8J x 20 with 245/35 R20 tyres, wheel size rear 9J x 20 with 275/30 R20 tyres.

BMW M5.



■ The 8-speed M Steptronic Sport transmission with DriveLogic features extremely short shifting times and numerous shifting options.



■ The Sport seats for the driver and front passenger provide optimum support due to their adjustable seat depth, bolsters on the backrest, backrest angle, seat angle and fore-and-aft position.



□ 20" M light alloy wheels Double-spoke style 810 M Bicolour Orbit Grey with mixed tyres, gloss-lathed, wheel size front 9.5J x 20 with 275/35 R20 tyres, wheel size rear 10.5J x 20 with 285/35 R20 tyres.

BMW M5 COMPETITION.

■ Standard equipment □ Optional equipment



■ The M Leather steering wheel including multifunction buttons, an M badge and an integrated driver-side airbag is featured in three-spoke design. With a steering wheel rim in leather 'Walknappa' Black with black stitching and contoured thumb rests, it provides a direct, athletic steering experience.

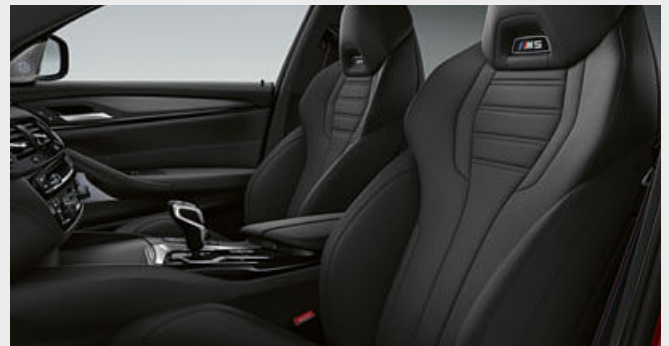

□ The M Multifunctional seats for driver and front passenger in exclusive design offer comprehensive adjustment possibilities and provide perfect support.



□ 20" M light alloy wheels Double-spoke style 706 M Black with mixed tyres, wheel size front 9.5J x 20 with 275/35 R20 tyres, wheel size rear 10.5J x 20 with 285/35 R20 tyres.



□ Thanks to the use of a special material mix, M Compound brakes with brake calipers in Red high-gloss achieve outstanding deceleration values and are extremely stable and highly durable.



■ The black "M5 Competition" designation on the rear is an indication of the vehicle's extraordinarily high driving dynamic potential.



■ As soon as the door is opened, the illuminated door sill finishers with "M5 Competition" designation increase the thrill of anticipation for the following driving experience.

*The availability of some equipment features and functions depends on engine variants or additional options. The market and production availability may vary. You can find detailed information about duration, standard and optional equipment at www.bmw.com or at your BMW Partner.

Further data in this catalogue refer to the BMW M5. You can find further information about point finishes, upholstery and equipment for the M550i xDrive shown here at www.bmw.com or at your BMW Partner.

HIGHLIGHTS.

Discover even more with the new BMW Brochures app. Available now, for your smartphone and tablet.

■ Standard equipment □ Optional equipment



□ In laser high-beam mode, BMW Laserlight illuminates a range of up to 650 m, nearly twice as far as that of conventional headlights. Better visibility in the dark significantly increases safety. Blue accents and the lettering "BMW Laser" in the headlight also underline the technological standards and the sportiness of the vehicle.



□ The M Carbon ceramic brake¹ delivers braking power more directly. It is non-corrosive, very resistant to abrasion, tolerates more heat and contributes to a lower vehicle weight, which has a positive impact on agility, dynamics and acceleration. Matt Gold-coloured brake calipers with the M designation make this special technical equipment visible from outside the vehicle.



■ The BMW Live Cockpit Professional with navigation function includes two high-quality displays consisting of a high-resolution 12.3" Control Display that can be operated by touch and a fully digital 12.3" instrument display. The BMW Operating System 7 can also be operated via the iDrive Touch Controller.



□ The Bowers & Wilkins Diamond surround sound system with two diamond tweeters features outstanding studio-quality sound for every seat in the vehicle. 16 carefully positioned speakers ensure a mesmerising sound experience. The speakers are illuminated, visually emphasising the system's outstanding sound quality.



■ As part of the intelligent lightweight construction concept, the M carbon-fibre roof helps to reduce the vehicle's weight. It consists of carbon-fibre reinforced plastic (CFRP) and is 800 g lighter than a comparable aluminium standard roof. That way, the centre of gravity of the vehicle is shifted downwards and the driving dynamics are increased.



■ The full-colour BMW Head-Up Display² with M specific functions projects information relevant for the journey directly into the driver's field of vision. With the press of a button, the driver can switch to the M specific display, which includes a gear indicator, the rpm as a dynamic range curve with shift lights indicating the optimal moment to shift as well as navigation tips.



■ Ambient light, including Ambient contour lighting in the front and rear doors, creates a relaxed, cosy lighting atmosphere in the interior. The six dimmable lighting designs also include a dynamic function in four applications.



□ Your vehicle key? No need for that anymore. With the BMW Digital Key⁵*, it is available directly on your compatible iPhone.



■ The M Setup allows you to configure various driving dynamics parameters according to your individual requirements.



□ Driving Assistant Professional³* offers optimum comfort and safety during critical or monotonous traffic situations. Apart from the contents of the Driving Assistant, it also includes Steering and Lane Control Assistant with extended functions, Emergency Stop Assistant and Lane Keeping Assistant with active side collision protection.



□ Parking Assistant Plus makes parking and manoeuvring the vehicle easier. It features among others the Surround View system including Top View, Panorama View, Remote 3D View, as well as a lateral parking aid, the emergency braking function Active Park Distance Control, Parking Assistant⁴ with longitudinal and lateral guidance and Reversing Assistant.

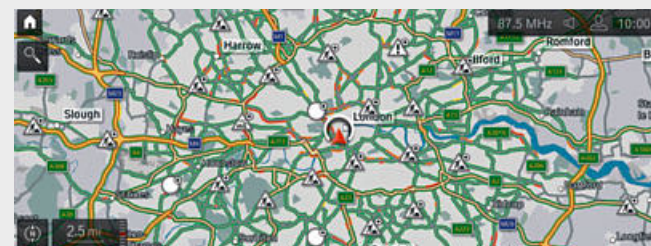

□ Concierge Service, Remote Services, smartphone integration incl. Apple CarPlay and Android Auto, In-Car Experiences, Connected Music or BMW Maps with Connected Navigation and Connected Parking? Why order them individually? Get them all! With the Connected Package Professional, you can get these BMW ConnectedDrive services as well as BMW Music to test free of charge.

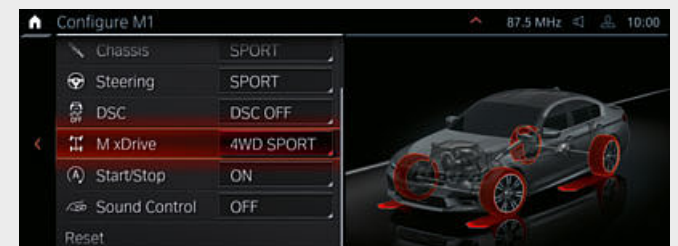

■ BMW M xDrive with Active M differential guarantees maximum traction and driving dynamics for everyday driving, as well as at the racetrack. The M specific technology combines the typical agility of a rear-wheel drive with the control of an all-wheel drive. You can choose between the drive variants 4WD, 4WD Sport and – in DSC-off mode – 2WD.

¹ Depending on conditions and usage, features specific to the materials used can lead to operational noises, particularly in wet conditions, just before the vehicle comes to a halt.

² The information in the BMW Head-Up Display is not fully visible when viewed through polarised sunglasses.

³ Function may be limited in darkness, fog or bright glare.

⁴ The driver is responsible for constantly monitoring the automated parking procedure in accordance with local road laws.

Some ConnectedDrive Services may differ between countries. Please consult your local BMW partner for more information.

⁵ Prerequisite is a BMW ConnectedDrive account and a compatible smartphone. For customers with a non-compatible smartphone, a high-quality Key Card is provided. More information about the BMW Digital Key, e.g. regarding the compatibility of your smartphone, is available at www.bmw.com/digitalkey

* The availability of some equipment features and functions depends on engine variants or additional options. The market and production availability may vary. You can find detailed information about duration, standard and optional equipment at www.bmw.com or at your BMW Partner.

EXTERIOR COLOURS.

Discover even more with the new BMW Brochures app. Available now, for your smartphone and tablet.

■ Standard equipment □ Optional equipment

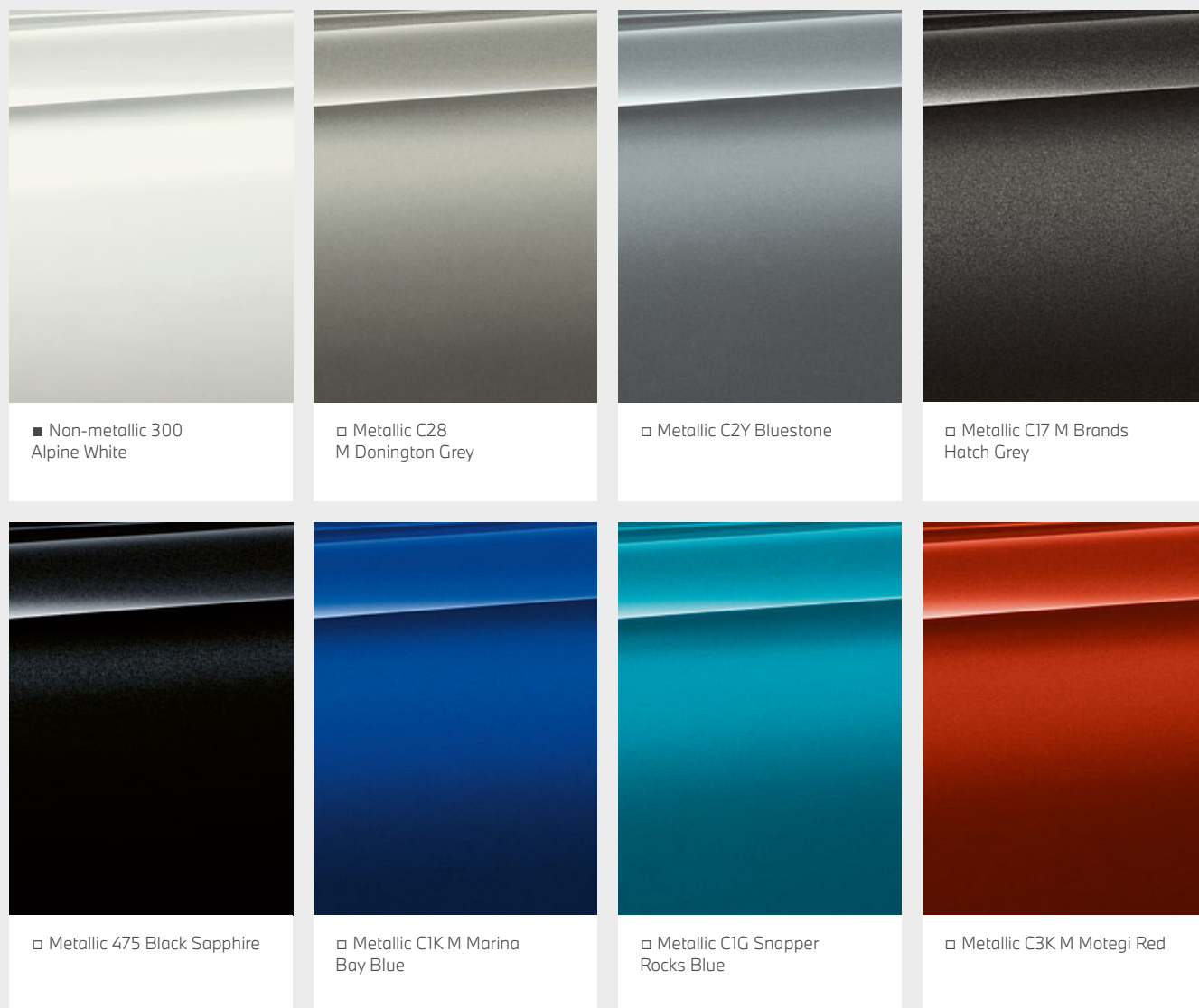

BMW INDIVIDUAL

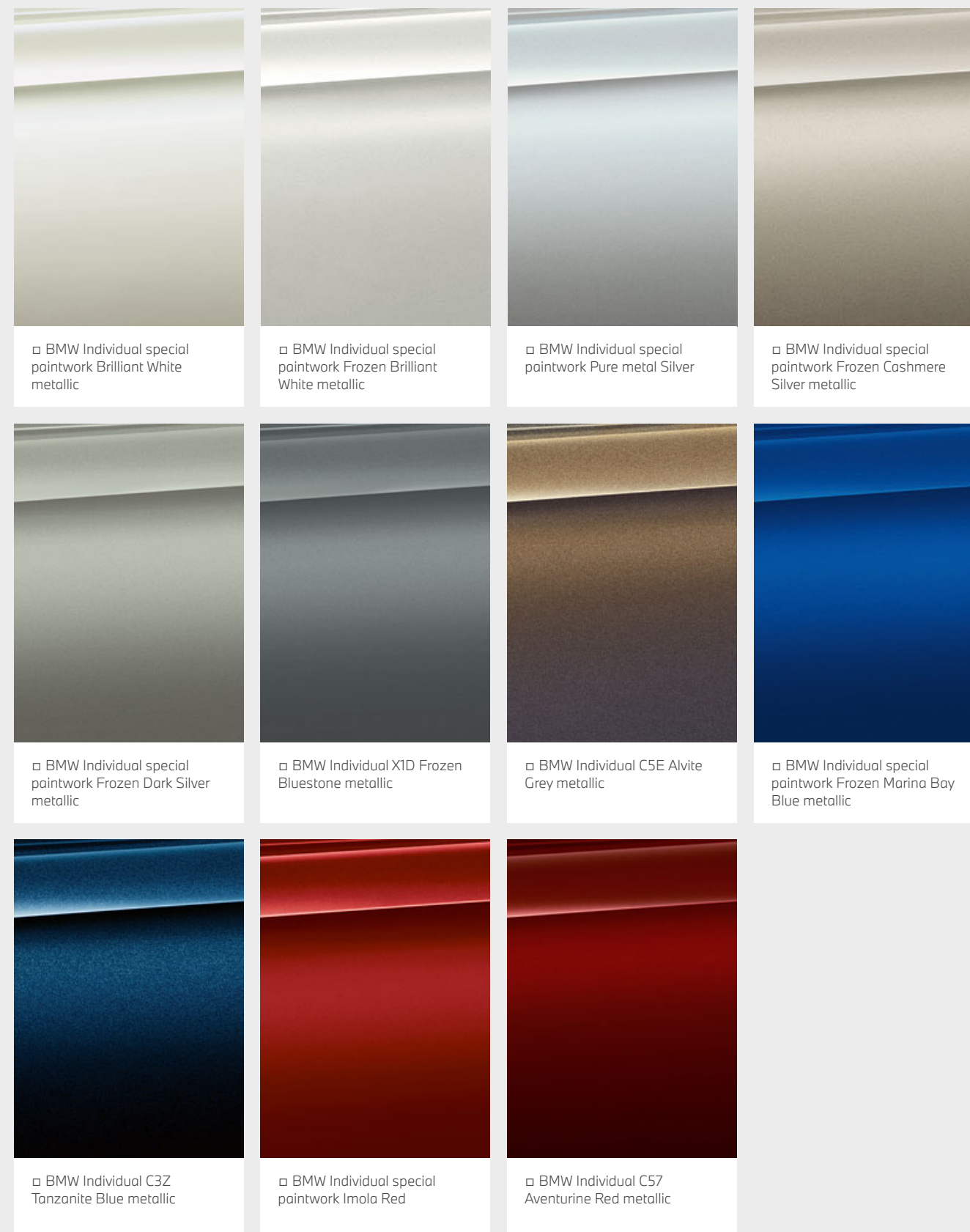

The availability of some equipment features and functions depends on engine variants or additional options. The market and production availability may vary. You can find detailed information about duration, standard and optional equipment at www.bmw.com or at your BMW Partner.

[Colour samples] These colour samples are intended as an initial guide to the colours and materials available for your BMW. However, experience has shown that printed versions of paint, upholstery and interior trim colours cannot in all cases faithfully

reproduce the appearance of the original colour. Please discuss your preferred colour choices with your BMW partner or in your dealership. There you can also see original samples and be assisted with special requests.

INTERIOR COLOURS.

Discover even more with the new BMW Brochures app. Available now, for your smartphone and tablet.

■ Standard equipment □ Optional equipment



LEATHER

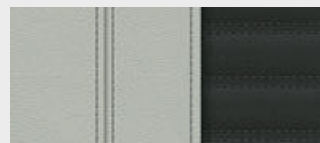

■ Leather 'Merino' LKA9 with extended contents Silverstone Bicolour*

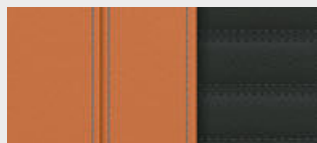

□ Leather 'Merino' LKD8 with extended contents Bicolour Aragon Brown*

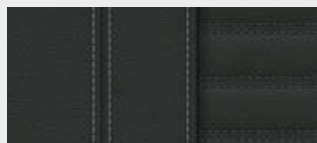

□ Leather 'Merino' LKSW with extended contents Black

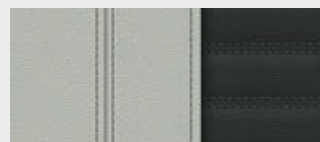

□ Full leather 'Merino' X3A9 Bicolour Silverstone*

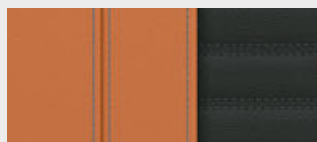

□ Full leather 'Merino' X3D8 Bicolour Aragon Brown*

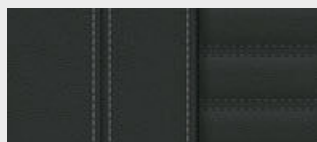

□ Full leather 'Merino' X3SW Black*

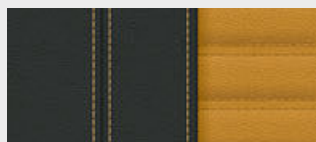

□ Full leather 'Merino' X3JA Black, contrast Midrand Beige¹*

BMW INDIVIDUAL LEATHER



□ BMW Individual full leather trim 'Merino' ZBFU Smoke White*

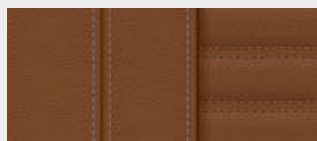

□ BMW Individual full leather trim 'Merino' ZBTQ Tartufo*

INTERIOR TRIM FINISHERS

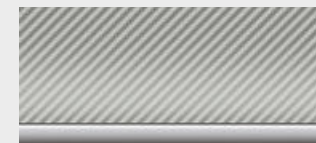

■ M interior trim finishers Aluminium Carbon structure with highlight trim finisher Pearl Chrome

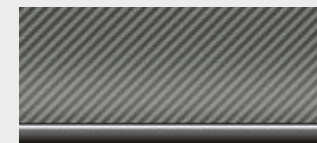

□ M interior trim finishers Aluminium Carbon structure dark with highlight trim finisher Chrome dark

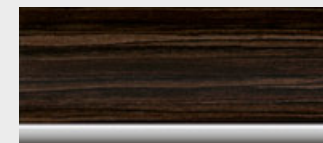

□ Fine-wood trim 'Fineline' Ridge with highlight trim finisher Pearl Chrome

BMW INDIVIDUAL INTERIOR TRIM FINISHERS



□ BMW Individual fine-wood trim Sen light brown with highlight trim finisher Pearl Chrome

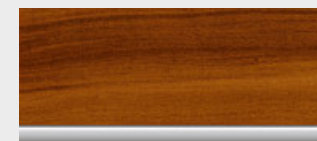

□ BMW Individual fine-wood trim plum brown high-gloss with highlight trim finisher Pearl Chrome



□ BMW Individual interior trim finishers piano finish Black with highlight trim finisher Pearl Chrome

Please note that even normal long- or short-term use can lead to unrecoverable upholstery damage. This can be caused in particular by non-colourfast clothing.

Please note that the interior colour depends on the selected upholstery colour.

¹ Only available for Competition models.

*The availability of some equipment features and functions depends on engine variants or additional options. The market and production availability may vary.

You can find detailed information about terms, standard and optional equipment at www.bmw.com or at your BMW Partner.

		BMW M550i xDrive	BMW M5	BMW M5 Competition
Weight				
Unladen weight EU ¹	kg	1990	1970	1970
Maximum permissible weight	kg	2560	2440	2440
Permitted load	kg	645	545	545
Permitted trailer load, unbraked ²	kg	750	750	750
Permitted trailer load, braked, max. 12% gradient/max. 8% gradient ²	kg	2000/2000	2000/2000	2000/2000
Luggage capacity	l	530	530	530
Engine⁴				
Cylinders/valves		8/4	8/4	8/4
Capacity	cm ³	4395	4395	4395
Max. output/engine speed	kW (hp)/rpm	390 (530)/5500–6000	441 (600)/6000	460 (625)/6000
Max. torque/engine speed	Nm/rpm	750/1800–4600	750/1800–5600	750/1800–5860
Power transmission				
Type of drive		All-wheel	M xDrive	M xDrive
Standard transmission		8-speed Steptronic Sport	M Steptronic	M Steptronic
Performance				
Top speed	km/h	250 ³	250 ³	250 ³
Top speed with optional M Driver's Package ⁶	km/h	–	305	305
Acceleration 0–100 km/h	s	3.8	3.4	3.3
Consumption^{4,5} – All engines conform to the EU6 standard				
Low	l/100 km	17.8–18.4	20.8–20.9	20.8–20.9
Medium	l/100 km	10.6–11.4	10.5–10.8	10.5–10.8
High	l/100 km	8.6–9.3	9.0–9.3	9.0–9.3
Maximum value	l/100 km	8.9–9.5	9.5–9.8	9.5–9.8
Combined	l/100 km	10.3–11.0	11.1–11.3	11.1–11.3
Exhaust emissions standard (type-certified)		EU6d	EU6d	EU6d
Combined CO ₂ emissions	g/km	235–250	253–259	253–259
Tank capacity, approx.	l	68	68	68
Wheels/tyres				
Tyre dimensions		Front: 245/40 R19 Y Rear: 275/35 R19 Y	Front: 275/40 ZR19 Y Rear: 285/40 ZR19 Y	Front: 275/35 ZR20 Y Rear: 285/35 ZR20 Y
Wheel size		Front: 8 J x 19 Rear: 9 J x 19	Front: 9.5 J x 19 Rear: 10.5 J x 19	Front: 9.5 J x 20 Rear: 10.5 J x 20
Material		Light alloy	Light alloy	Light alloy

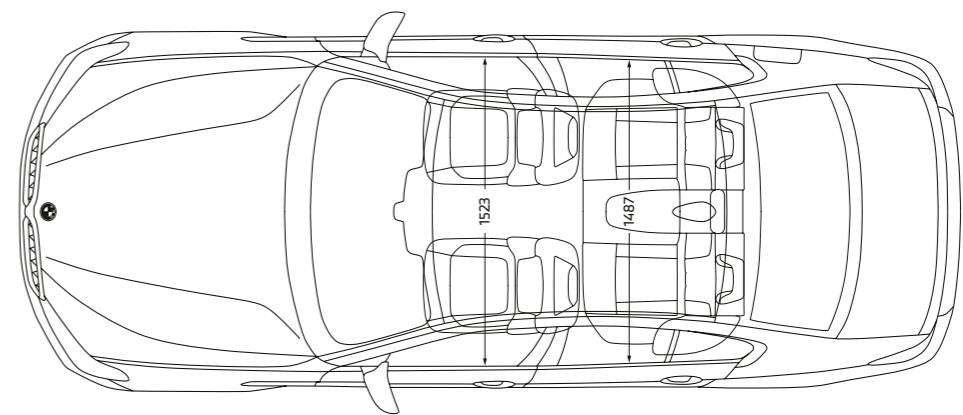
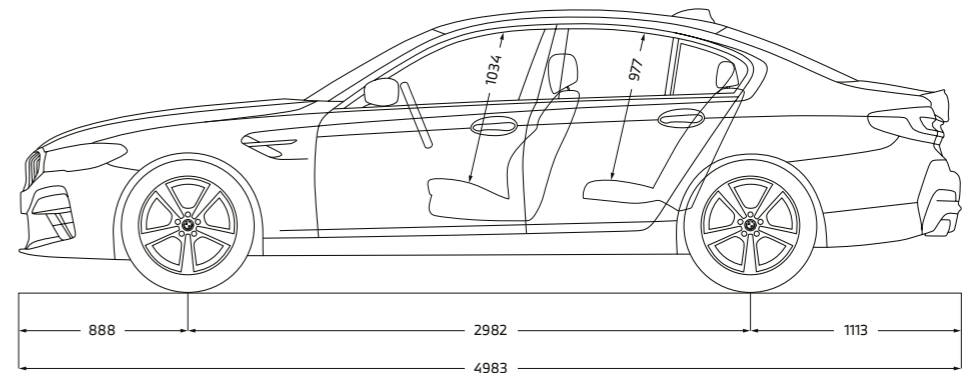
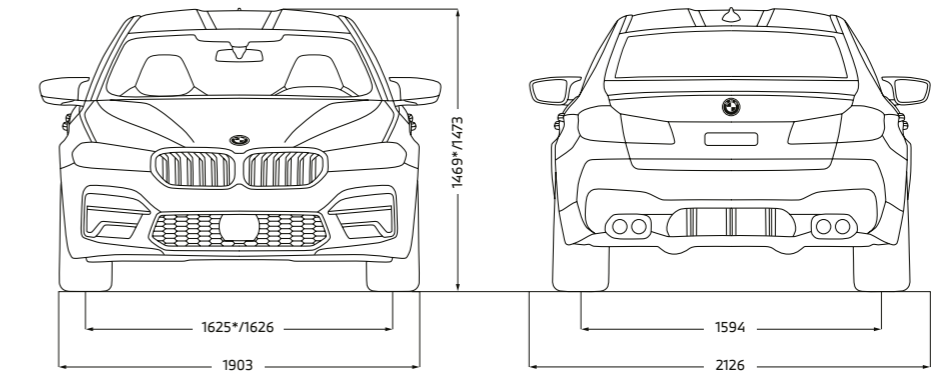

* BMW M5 Competition

The dimensions in the technical drawing are in millimetres and may vary depending on the model and optional equipment.

¹ The EC unladen weight refers to a vehicle with standard equipment and does not include any optional extras. The unladen weight includes a 90% full tank and a driver weight of 75 kg. Optional equipment may affect the weight of the vehicle, the payload and the top speed if the selected equipment has an impact on the vehicle's aerodynamics.

² The actual total weight of the trailer must not exceed the maximum trailer load, taking into account the maximum tow bar download.

³ Electronically limited.

⁴ Performance data of petrol engines apply to vehicles using RON 98 fuel. Fuel consumption data apply to vehicles using reference fuels in accordance with EU Regulation 2007/715. Unleaded RON 91 and higher with a maximum ethanol content of 10% (E10) may also be used. BMW recommends RON 95 super unleaded petrol.

⁵ Official data for fuel consumption and CO₂ emissions was determined in accordance with the prescribed measuring procedure and corresponds to European Regulation (EC) 715/2007 in the applicable version. For ranges, data determined as per WLTP takes into account any optional equipment (available on the German market in this case). For vehicles that have been newly type approved since 1 January 2021, only the official data according to WLTP exists. For more information about NEDC and WLTP measuring procedures visit www.bmw.com/wltp

⁶ The raised top speed is only available after the first service following the 2,000 km run-in period.



ALL BMW MODELS IN ONE APP.

DOWNLOAD THE **BMW Products** APP NOW
AND DISCOVER THE PLEASURE OF DRIVING.

BMW M5 COMPETITION:

BMW M TwinPower Turbo 8-cylinder petrol engine, 460 kW (625 hp), 20" M light alloy wheels Double-spoke style 706 M Jet Black with mixed tyres, exterior colour in BMW Individual Imola Red, M multifunction seats for driver and front passenger in full leather trim 'Merino' Black, interior trim finishers Aluminium Carbon structure dark with highlight trim finisher Chrome dark.

The models illustrated in this medium show the equipment and configuration options (standard and optional) for vehicles produced by BMW AG for the German market. Alterations in standard and optional equipment and the configurations available for the different models, as described in this medium, may occur after 03/19/2021, the editorial deadline for this medium, or according to the specific requirements of other member states of the European Union. Your local BMW Partner is available to provide further details. Subject to change in design and equipment.

Of course, each vehicle is designed for economical recycling after its long-running life. You can find more information regarding your end-of-life vehicle on our website www.bmw.de/recycling

© BMW AG, Munich, Germany. Not to be reproduced wholly or in part without prior written permission of BMW AG, Munich.